

VPS 36-1200

Electrical Specifications (@25C)

1. Maximum Power: 43.0VA
2. Secondary: Series: 36.0V CT@ 1.2A
Parallel: 18.0V @ 2.4.A
3. Voltage Regulation: 25% TYP @ full load to no load
4. Temperature Rise: 30C TYP (45C MAX allowed)
5. Insulation Resistance: 100MΩ

Construction:

Dual bobbin construction with an insulated shroud, both made of a high temperature material that exceeds UL flammability requirements.

Safety:

These units are designed with 4000VAC isolation between the primary and secondary, and also, between each winding and the core. Since the dual bobbin construction effectively reduces capacitance, electrostatic shielding is not required. World Series Transformers are designed and manufactured to meet the following agency approvals:



Agency File:

UL: File E53148, UL 506, General Purpose.
CSA: File LR 37220. C22.2 NO. 66, General Purpose.
VDE: File 18786-3390-0001, VDE/EN 60 950, (IEC950) information Technology Equipment.

A. Dimensions:

Unit: In inches

| H | W | D | A | B | C | T | MW | ML |
|---------|-------|---|--------|-------|------|------|---------|----|
| 2-11/16 | 3-1/8 | 2 | 2-5/16 | 1-1/8 | 5/16 | 3/16 | 2-13/16 | - |

B. Mounting Hole Size: 3/16"

C. WT Lbs. : 1.6

D. Schematic Diagram:

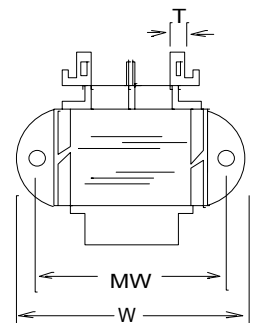
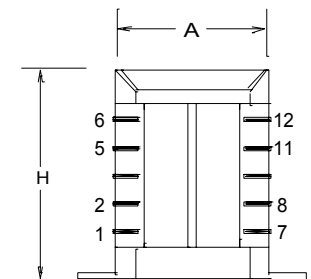
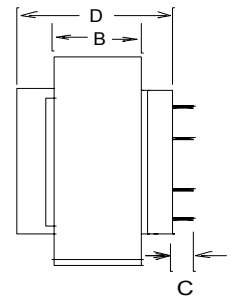
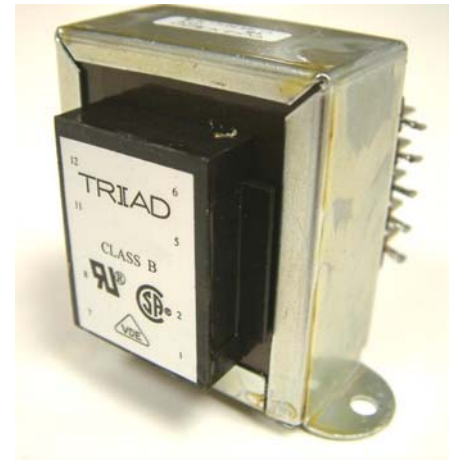
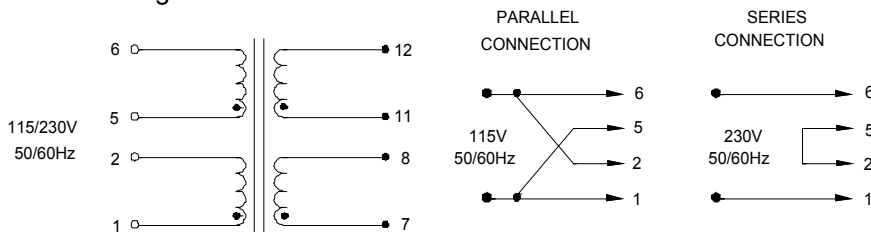

RoHS Compliance: As of manufacturing date February 2005, all standard products meet the requirements of 2002/95/EC, known as the RoHS initiative.

Power Transformers

VDE File: 18786-3390-0001

Class B

UL File: E53148

CSA File: 221330



Chassis Mount: Quick-Connect World Series™

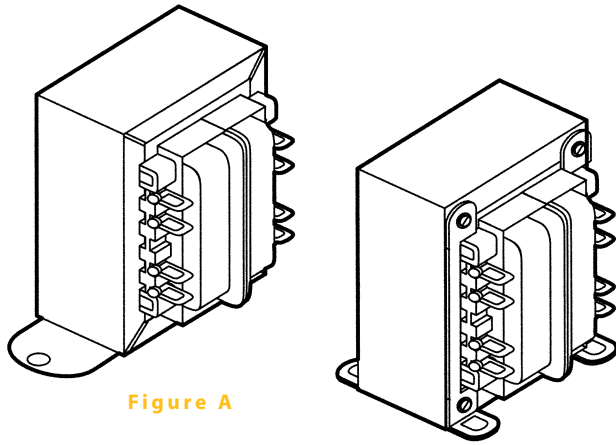

Figure A

Figure B

:: Description

Triad chassis mount World Series transformers are designed to meet U.S. and International standards including CSA, IEC, VDE and UL requirements. The transformers consist of a dual bobbin design positioned inside an insulating shroud and constructed with UL approved high temperature material. This design eliminates the need for electrostatic shielding since there is minimal capacitance between coils when using a dual bobbin configuration. The primary and secondary are both electrically isolated from each other, and from the core itself. Chassis mount World Series transformers are available in sizes ranging from 25 VA to 175 VA, and are equipped with convenient “quick connect” terminations.

:: Specifications

Primary: 115/230 V, 50/60 Hz

:: World Series

| Section | Type No. | VA | Secondary | | Dimensions | | | | | | | Mounting | | Wt. Lbs. | |
|---------|-------------|-----|-------------------|----------------|--------------------------------|--------------------------------|--------------------------------|--------------------------------|-------------------------------|--------------------------------|--------------------------------|----------|--------------------------------|-------------------------------|------|
| | | | Series | Parallel | H | W | D | A | B | C | T | Figure | MW | | ML |
| A | VPS10-2500 | 25 | 10.0V CT @ 2.5A | 5.0V @ 5.0A | 2 ¹ / ₁₆ | 2 ¹ / ₁₆ | 1 ¹ / ₁₆ | 2 | 1 ¹ / ₈ | 3 ¹ / ₁₆ | 3 ¹ / ₁₆ | A | 2 ³ / ₈ | • | 1.25 |
| | VPS10-4300 | 43 | 10.0V CT @ 4.3A | 5.0V @ 8.6A | 2 ¹ / ₁₆ | 3 ¹ / ₈ | 2 | 2 ¹ / ₁₆ | 1 ¹ / ₈ | 3 ¹ / ₁₆ | 3 ¹ / ₁₆ | A | 2 ¹ / ₁₆ | • | 1.60 |
| | VPS10-8000 | 80 | 10.0V CT @ 8.0A | 5.0V @ 16.0A | 3 | 2 ¹ / ₂ | 2 ¹ / ₁₆ | • | 1 ¹ / ₈ | 3 ¹ / ₁₆ | 3 ¹ / ₁₆ | B | 2 | 2 ¹ / ₄ | 2.80 |
| | VPS10-13000 | 130 | 10.0V CT @ 13.0A | 5.0V @ 26.0A | 3 ³ / ₈ | 2 ¹ / ₁₆ | 2 ¹ / ₁₆ | • | 1 ¹ / ₈ | 3 ¹ / ₈ | 3 ¹ / ₄ | B | 2 ¹ / ₄ | 2 ¹ / ₂ | 4.10 |
| | VPS10-17500 | 175 | 10.0V CT @ 17.5A | 5.0V @ 35.0A | 3 ³ / ₈ | 3 ¹ / ₈ | 2 ¹ / ₁₆ | • | 1 ¹ / ₈ | 3 ¹ / ₈ | 3 ¹ / ₄ | B | 2 ¹ / ₂ | 2 ¹ / ₂ | 5.50 |
| B | VPS12-2000 | 25 | 12.6V CT @ 2.0A | 6.3V @ 4.0A | 2 ¹ / ₁₆ | 2 ¹ / ₁₆ | 1 ¹ / ₁₆ | 2 | 1 ¹ / ₈ | 3 ¹ / ₁₆ | 3 ¹ / ₁₆ | A | 2 ³ / ₈ | • | 1.25 |
| | VPS12-3400 | 43 | 12.6V CT @ 3.4A | 6.3V @ 6.8A | 2 ¹ / ₁₆ | 3 ¹ / ₈ | 2 | 2 ¹ / ₁₆ | 1 ¹ / ₈ | 3 ¹ / ₁₆ | 3 ¹ / ₁₆ | A | 2 ¹ / ₁₆ | • | 1.60 |
| | VPS12-6300 | 80 | 12.6V CT @ 6.3A | 6.3V @ 12.6A | 3 | 2 ¹ / ₂ | 2 ¹ / ₁₆ | • | 1 ¹ / ₈ | 3 ¹ / ₁₆ | 3 ¹ / ₁₆ | B | 2 | 2 ¹ / ₄ | 2.80 |
| | VPS12-10300 | 130 | 12.6V CT @ 10.3A | 6.3V @ 20.6A | 3 ³ / ₈ | 2 ¹ / ₁₆ | 2 ¹ / ₁₆ | • | 1 ¹ / ₈ | 3 ¹ / ₈ | 3 ¹ / ₄ | B | 2 ¹ / ₄ | 2 ¹ / ₂ | 4.10 |
| | VPS12-14000 | 175 | 12.6V CT @ 14.0A | 6.3V @ 28.0A | 3 ³ / ₈ | 3 ¹ / ₈ | 2 ¹ / ₁₆ | • | 1 ¹ / ₈ | 3 ¹ / ₈ | 3 ¹ / ₄ | B | 2 ¹ / ₂ | 2 ¹ / ₂ | 5.50 |
| C | VPS16-1600 | 25 | 16.0V CT @ 1.6A | 8.0V @ 3.2A | 2 ¹ / ₁₆ | 2 ¹ / ₁₆ | 1 ¹ / ₁₆ | 2 | 1 ¹ / ₈ | 3 ¹ / ₁₆ | 3 ¹ / ₁₆ | A | 2 ³ / ₈ | • | 1.25 |
| | VPS16-2700 | 43 | 16.0V CT @ 2.7A | 8.0V @ 5.4A | 2 ¹ / ₁₆ | 3 ¹ / ₈ | 2 | 2 ¹ / ₁₆ | 1 ¹ / ₈ | 3 ¹ / ₁₆ | 3 ¹ / ₁₆ | A | 2 ¹ / ₁₆ | • | 1.60 |
| | VPS16-5000 | 80 | 16.0V CT @ 5.0A | 8.0V @ 10.0A | 3 | 2 ¹ / ₂ | 2 ¹ / ₁₆ | • | 1 ¹ / ₈ | 3 ¹ / ₁₆ | 3 ¹ / ₁₆ | B | 2 | 2 ¹ / ₄ | 2.80 |
| | VPS16-8100 | 130 | 16.0V CT @ 8.1A | 8.0V @ 16.2A | 3 ³ / ₈ | 2 ¹ / ₁₆ | 2 ¹ / ₁₆ | • | 1 ¹ / ₈ | 3 ¹ / ₈ | 3 ¹ / ₄ | B | 2 ¹ / ₄ | 2 ¹ / ₂ | 4.10 |
| | VPS16-11000 | 175 | 16.0V CT @ 11.0A | 8.0V @ 22.0A | 3 ³ / ₈ | 3 ¹ / ₈ | 2 ¹ / ₁₆ | • | 1 ¹ / ₈ | 3 ¹ / ₈ | 3 ¹ / ₄ | B | 2 ¹ / ₂ | 2 ¹ / ₂ | 5.50 |
| D | VPS20-1250 | 25 | 20.0V CT @ 1.25A | 10.0V @ 2.5A | 2 ¹ / ₁₆ | 2 ¹ / ₁₆ | 1 ¹ / ₁₆ | 2 | 1 ¹ / ₈ | 3 ¹ / ₁₆ | 3 ¹ / ₁₆ | A | 2 ³ / ₈ | • | 1.25 |
| | VPS20-2200 | 43 | 20.0V CT @ 2.2A | 10.0V @ 4.4A | 2 ¹ / ₁₆ | 3 ¹ / ₈ | 2 | 2 ¹ / ₁₆ | 1 ¹ / ₈ | 3 ¹ / ₁₆ | 3 ¹ / ₁₆ | A | 2 ¹ / ₁₆ | • | 1.60 |
| | VPS20-4000 | 80 | 20.0V CT @ 4.0A | 10.0V @ 8.0A | 3 | 2 ¹ / ₂ | 2 ¹ / ₁₆ | • | 1 ¹ / ₈ | 3 ¹ / ₁₆ | 3 ¹ / ₁₆ | B | 2 | 2 ¹ / ₄ | 2.80 |
| | VPS20-6500 | 130 | 20.0V CT @ 6.5A | 10.0V @ 13.0A | 3 ³ / ₈ | 2 ¹ / ₁₆ | 2 ¹ / ₁₆ | • | 1 ¹ / ₈ | 3 ¹ / ₈ | 3 ¹ / ₄ | B | 2 ¹ / ₄ | 2 ¹ / ₂ | 4.10 |
| | VPS20-8800 | 175 | 20.0V CT @ 8.8A | 10.0V @ 17.6A | 3 ³ / ₈ | 3 ¹ / ₈ | 2 ¹ / ₁₆ | • | 1 ¹ / ₈ | 3 ¹ / ₈ | 3 ¹ / ₄ | B | 2 ¹ / ₂ | 2 ¹ / ₂ | 5.50 |
| E | VPS24-1000 | 25 | 24.0V CT @ 1.0A | 12.0V @ 2.0A | 2 ¹ / ₁₆ | 2 ¹ / ₁₆ | 1 ¹ / ₁₆ | 2 | 1 ¹ / ₈ | 3 ¹ / ₁₆ | 3 ¹ / ₁₆ | A | 2 ³ / ₈ | • | 1.25 |
| | VPS24-1800 | 43 | 24.0V CT @ 1.8A | 12.0V @ 3.6A | 2 ¹ / ₁₆ | 3 ¹ / ₈ | 2 | 2 ¹ / ₁₆ | 1 ¹ / ₈ | 3 ¹ / ₁₆ | 3 ¹ / ₁₆ | A | 2 ¹ / ₁₆ | • | 1.60 |
| | VPS24-3300 | 80 | 24.0V CT @ 3.3A | 12.0V @ 6.6A | 3 | 2 ¹ / ₂ | 2 ¹ / ₁₆ | • | 1 ¹ / ₈ | 3 ¹ / ₁₆ | 3 ¹ / ₁₆ | B | 2 | 2 ¹ / ₄ | 2.80 |
| | VPS24-5400 | 130 | 24.0V CT @ 5.4A | 12.0V @ 10.8A | 3 ³ / ₈ | 2 ¹ / ₁₆ | 2 ¹ / ₁₆ | • | 1 ¹ / ₈ | 3 ¹ / ₈ | 3 ¹ / ₄ | B | 2 ¹ / ₄ | 2 ¹ / ₂ | 4.10 |
| | VPS24-7300 | 175 | 24.0V CT @ 7.3A | 12.0V @ 14.6A | 3 ³ / ₈ | 3 ¹ / ₈ | 2 ¹ / ₁₆ | • | 1 ¹ / ₈ | 3 ¹ / ₈ | 3 ¹ / ₄ | B | 2 ¹ / ₂ | 2 ¹ / ₂ | 5.50 |
| F | VPS28-900 | 25 | 28.0V CT @ 0.9A | 14.0V @ 1.8A | 2 ¹ / ₁₆ | 2 ¹ / ₁₆ | 1 ¹ / ₁₆ | 2 | 1 ¹ / ₈ | 3 ¹ / ₁₆ | 3 ¹ / ₁₆ | A | 2 ³ / ₈ | • | 1.25 |
| | VPS28-1500 | 43 | 28.0V CT @ 1.5A | 14.0V @ 3.0A | 2 ¹ / ₁₆ | 3 ¹ / ₈ | 2 | 2 ¹ / ₁₆ | 1 ¹ / ₈ | 3 ¹ / ₁₆ | 3 ¹ / ₁₆ | A | 2 ¹ / ₁₆ | • | 1.60 |
| | VPS28-2800 | 80 | 28.0V CT @ 2.8A | 14.0V @ 5.6A | 3 | 2 ¹ / ₂ | 2 ¹ / ₁₆ | • | 1 ¹ / ₈ | 3 ¹ / ₁₆ | 3 ¹ / ₁₆ | B | 2 | 2 ¹ / ₄ | 2.80 |
| | VPS28-4600 | 130 | 28.0V CT @ 4.6A | 14.0V @ 9.2A | 3 ³ / ₈ | 2 ¹ / ₁₆ | 2 ¹ / ₁₆ | • | 1 ¹ / ₈ | 3 ¹ / ₈ | 3 ¹ / ₄ | B | 2 ¹ / ₄ | 2 ¹ / ₂ | 4.10 |
| | VPS28-6250 | 175 | 28.0V CT @ 6.25A | 14.0V @ 12.5A | 3 ³ / ₈ | 3 ¹ / ₈ | 2 ¹ / ₁₆ | • | 1 ¹ / ₈ | 3 ¹ / ₈ | 3 ¹ / ₄ | B | 2 ¹ / ₂ | 2 ¹ / ₂ | 5.50 |
| G | VPS36-700 | 25 | 36.0V CT @ 0.7A | 18.0V @ 1.4A | 2 ¹ / ₁₆ | 2 ¹ / ₁₆ | 1 ¹ / ₁₆ | 2 | 1 ¹ / ₈ | 3 ¹ / ₁₆ | 3 ¹ / ₁₆ | A | 2 ³ / ₈ | • | 1.25 |
| | VPS36-1200 | 43 | 36.0V CT @ 1.2A | 18.0V @ 2.4A | 2 ¹ / ₁₆ | 3 ¹ / ₈ | 2 | 2 ¹ / ₁₆ | 1 ¹ / ₈ | 3 ¹ / ₁₆ | 3 ¹ / ₁₆ | A | 2 ¹ / ₁₆ | • | 1.60 |
| | VPS36-2200 | 80 | 36.0V CT @ 2.2A | 18.0V @ 4.4A | 3 | 2 ¹ / ₂ | 2 ¹ / ₁₆ | • | 1 ¹ / ₈ | 3 ¹ / ₁₆ | 3 ¹ / ₁₆ | B | 2 | 2 ¹ / ₄ | 2.80 |
| | VPS36-3600 | 130 | 36.0V CT @ 3.6A | 18.0V @ 7.2A | 3 ³ / ₈ | 2 ¹ / ₁₆ | 2 ¹ / ₁₆ | • | 1 ¹ / ₈ | 3 ¹ / ₈ | 3 ¹ / ₄ | B | 2 ¹ / ₄ | 2 ¹ / ₂ | 4.10 |
| | VPS36-4800 | 175 | 36.0V CT @ 4.8A | 18.0V @ 9.6A | 3 ³ / ₈ | 3 ¹ / ₈ | 2 ¹ / ₁₆ | • | 1 ¹ / ₈ | 3 ¹ / ₈ | 3 ¹ / ₄ | B | 2 ¹ / ₂ | 2 ¹ / ₂ | 5.50 |
| H | VPS56-2300 | 80 | 36.0V CT @ 2.3A | 28.0V @ 4.6A | 3 ³ / ₈ | 2 ¹ / ₈ | 3 ¹ / ₁₆ | 2 ¹ / ₈ | 1 ¹ / ₂ | 3 ¹ / ₈ | 3 ¹ / ₄ | B | 2 ¹ / ₄ | 2 ¹ / ₂ | 4.2 |
| I | VPS230-110 | 25 | 230.0V CT @ 0.11A | 115.0V @ 0.22A | 2 ¹ / ₁₆ | 2 ¹ / ₁₆ | 1 ¹ / ₁₆ | 2 | 1 ¹ / ₈ | 3 ¹ / ₁₆ | 3 ¹ / ₁₆ | A | 2 ³ / ₈ | • | 1.25 |
| | VPS230-190 | 43 | 230.0V CT @ 0.19A | 115.0V @ 0.38A | 2 ¹ / ₁₆ | 3 ¹ / ₈ | 2 | 2 ¹ / ₁₆ | 1 ¹ / ₈ | 3 ¹ / ₁₆ | 3 ¹ / ₁₆ | A | 2 ¹ / ₁₆ | • | 1.60 |
| | VPS230-350 | 80 | 230.0V CT @ 0.35A | 115.0V @ 0.7A | 3 | 2 ¹ / ₂ | 2 ¹ / ₁₆ | • | 1 ¹ / ₈ | 3 ¹ / ₁₆ | 3 ¹ / ₁₆ | B | 2 | 2 ¹ / ₄ | 2.80 |
| | VPS230-570 | 130 | 230.0V CT @ 0.57A | 115.0V @ 1.14A | 3 ³ / ₈ | 2 ¹ / ₁₆ | 2 ¹ / ₁₆ | • | 1 ¹ / ₈ | 3 ¹ / ₈ | 3 ¹ / ₄ | B | 2 ¹ / ₄ | 2 ¹ / ₂ | 4.10 |
| | VPS230-760 | 175 | 230.0V CT @ 0.76A | 115.0V @ 1.52A | 3 ³ / ₈ | 3 ¹ / ₈ | 2 ¹ / ₁₆ | • | 1 ¹ / ₈ | 3 ¹ / ₈ | 3 ¹ / ₄ | B | 2 ¹ / ₂ | 2 ¹ / ₂ | 5.50 |

CT = Center Tap Mounting Hole Sizes: 25 VA, 43 VA = 3/16" 80 VA, 130 VA, 175 VA = 13/64 x 3/8"

:: Outline Dimensions

Technical Notes

1. Hi-pot tested at 4,000 VRMS.
2. Both primary and secondary coils may be connected as either series or parallel, but both must be used simultaneously.

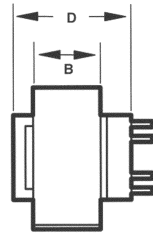
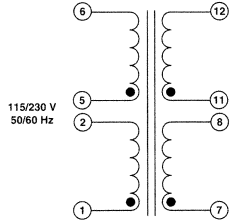

Figure A

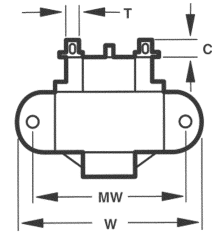
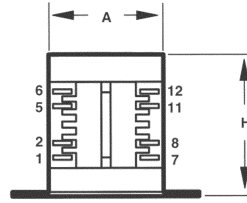

Figure B

